

How to Measure Outdoor Bar Island Covers - Design 1

Measurement Instruction

- ✓ Give exact measurement from edge to edge.
- ✓ We add 1" to 2" leeway on the given width/depth for easy pull-in and pull-out.
- ✓ The height dimensions will remain same as provided by you.

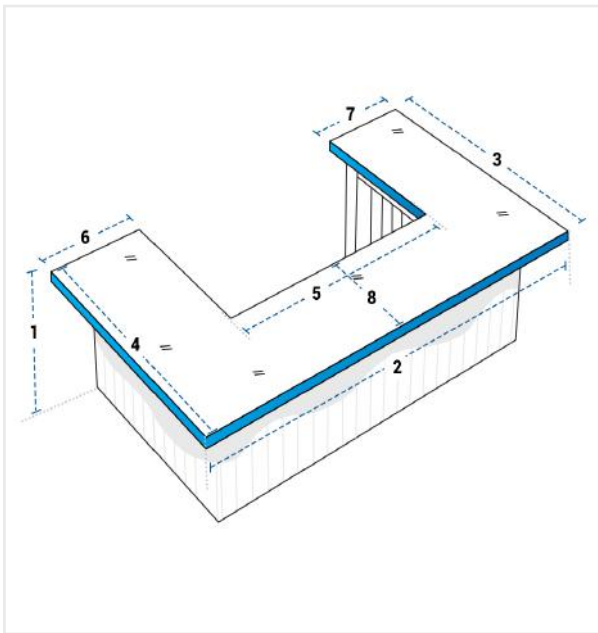

Measurement (Inches)

1. Height	<input type="text"/>	2. Outer Side Width	<input type="text"/>
3. Upper Depth	<input type="text"/>	4. Lower Depth	<input type="text"/>
5. Inside Width	<input type="text"/>	6. Left Arm Width	<input type="text"/>
7. Right Arm Width	<input type="text"/>	8. Middle Depth	<input type="text"/>

1. Height:
Height of the Outdoor Bar Island

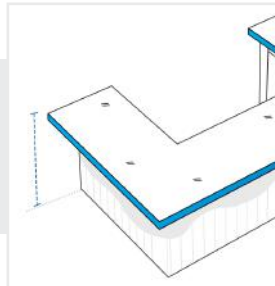

2. Outer Side Width:
Outer Side Width (Front side) of the Outdoor Bar Island

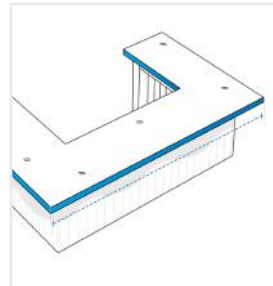

3. Upper Depth:
Upper Depth of the Outdoor Bar Island

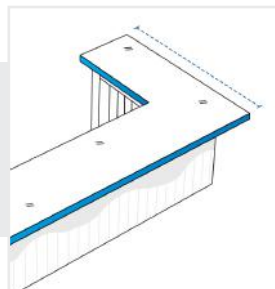

4. Lower Depth:
Lower Depth of the Outdoor Bar Island

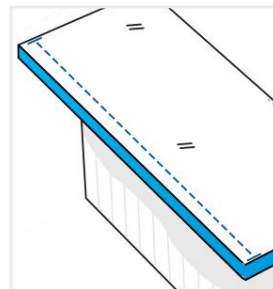

5. Inside Width:
Inside Width of the Outdoor Bar Island

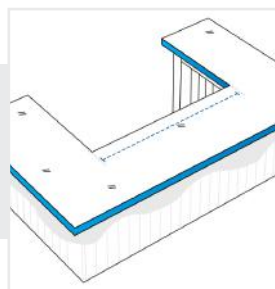

6. Left Arm Width:
Left Arm Width of the Outdoor Bar Island

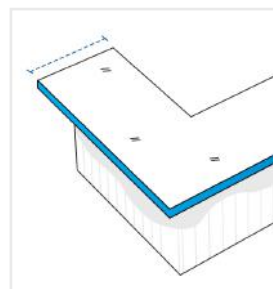

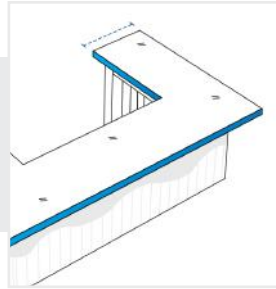

7. Right Arm Width:

Right Arm Width of the Outdoor Bar Island

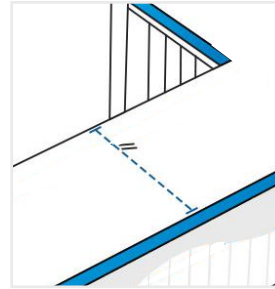

8. Middle Depth:

Middle Depth of the Outdoor Bar Island